



The Obvious Choice
NAVIGATOR

3000 / 3500 / 4000 / 4500 / 6000 / 6200



The Obvious Choice NAVIGATOR

3000 / 3500 / 4000 / 4500 / 6000 / 6200

The Obvious Choice

NAVIGATOR is synonymous with high quality and design which supports functionality. Properties which ensures the ultimate value for your money and ease of use. In the HARDI trailer family, NAVIGATOR offers features from mid-size to full specification solutions.

The large range of high quality features makes the NAVIGATOR the obvious choice.

Concept

Demands for simple and reliable solutions, serviceability and high capacity are universal world-wide.

This product represents HARDI's experience as sprayer specialist. The success for NAVIGATOR sprayers since their introduction has clearly proven the ultimate value of this product.

NAVIGATOR Model Options

Configurations to fit your Operation

Navigator 4500

Navigator 6200

NAVIGATOR 4000



STANDARD CONFIGURATION SPECIFICATIONS

- ▶ **Model:** 3000 / 3500 / 4000 / 6000
- ▶ **Capacity:** 800/1000/1200/1600 gallons
- ▶ **Controller:** Spray II (Optional HC5500, HC8600, HC9600 or ISOBUS)
- ▶ **TurboFiller (Option):** Efficient handling of liquid and powder
- ▶ **Liquid system:** Manual Smart Valve (Optional DynamicFluid4) on NAV 4500 & 6200
- ▶ **Filters:** Easy Clean (Suction) & Cyclone (Pressure)
- ▶ **Axle:** Fixed 60". Optional Fixed 120" or Adjustable 60" - 120"
- ▶ **Booms:**
 - EAGLE: Simple and strong booms:
 - Eagle SPB - 45 ft to 66 ft
 - Eagle SPC - 80 ft to 100 ft
 - Eagle SPC - DualFold 90/60 ft and 120/90 ft
 - DELTA FORCE (NAV 4500 & 6200): For higher speeds and greater performance 90ft, 120ft & 132 ft

NAVIGATOR 4500

- ▶ 1200 gallon tank capacity
- ▶ 90 ft Delta Force Boom
- ▶ 60" Fixed tubular steel axle
- ▶ 320/90 R46 Tires
- ▶ 464/12 HARDI Diaphragm 540 or 1000 RPM Pump
- ▶ Boom Hydraulic - HZ-DHP Simultaneous fold, individual tilt and center lift
- ▶ 54 Triplet Nozzle bodies on 20" spacing
- ▶ Polypropylene boom tubes (upgradeable to SS)
- ▶ EFC Controls with DynamicFluid 4
- ▶ ISO-BUS Electric Controls (must select display)

NAVIGATOR 6200

- ▶ 1600 gallon tank capacity
- ▶ 120ft or 132ft Delta Force booms (aluminum break-away on 120ft or carbon fiber breakaway on the 132ft)
- ▶ 120" Fixed tubular steel axle
- ▶ SmoothRide axle suspension
- ▶ 320/90 R50 Tires
- ▶ 464/12 HARDI Diaphragm 540 or 1000 RPM Pump
- ▶ Boom Hydraulic - HZ-DHP Simultaneous fold, individual tilt and center lift
- ▶ 72 Triplet Nozzle bodies on 20" or 22" spacing dependent of boom size.
- ▶ 120' has 20' spacing
- ▶ 132 has 22' spacing
- ▶ Polypropylene boom tubes (upgradeable to SS)
- ▶ EFC Controls with DynamicFluid 4
- ▶ ISO-BUS Electric Controls (must select display)
- ▶ Electric pressure transducer (rate controller required)

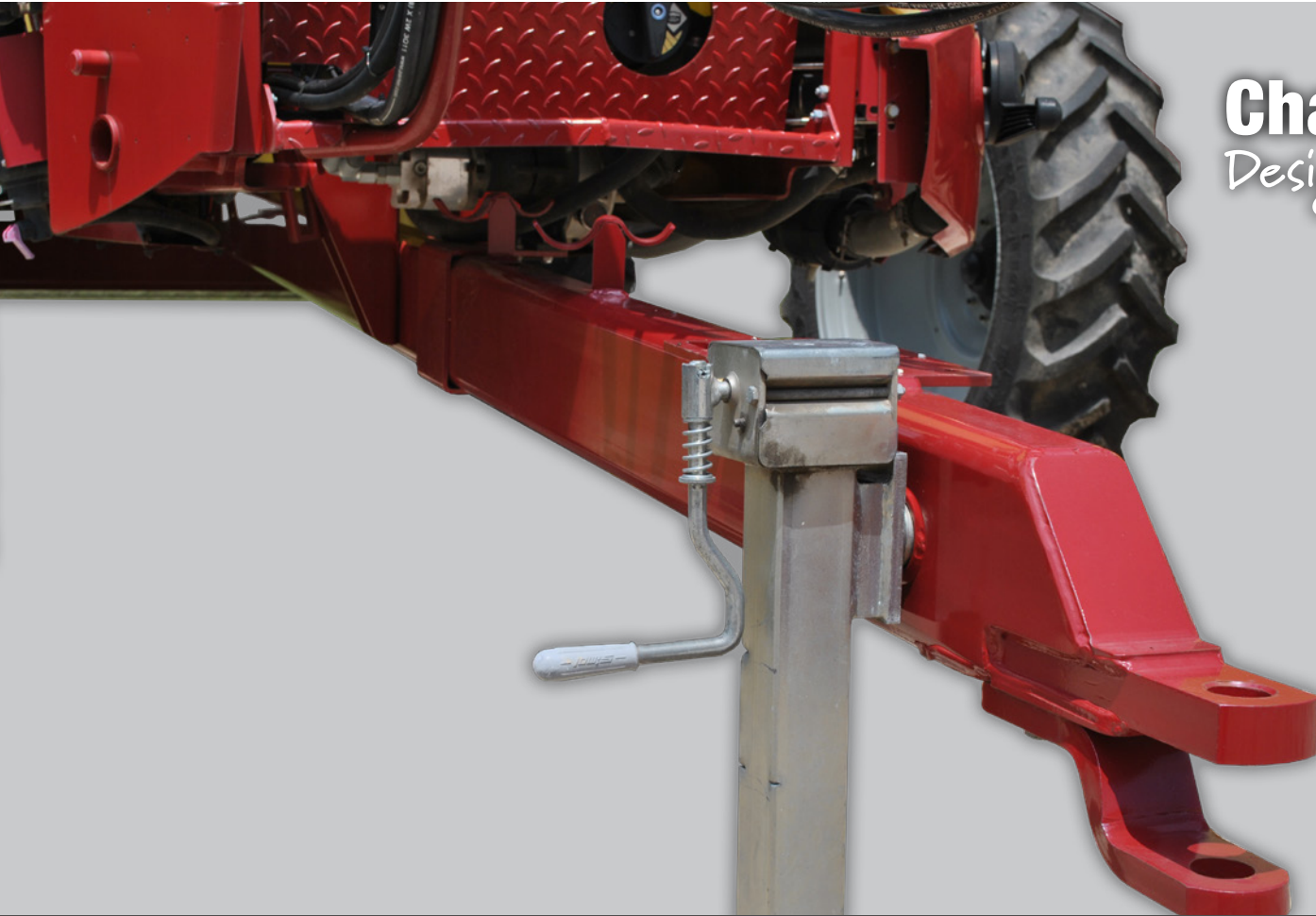

Chassis

Designed for high-speed driving

The heavy-duty NAVIGATOR chassis and axles are designed for high-speed driving under the most demanding field and road conditions. The robust NAVIGATOR frame is made of high-tensile steel and is ready to meet the tough demands of the professional farmer.

This concept gives the best compromise between excellent clearance and low center of gravity.

Low center of gravity

The entire NAVIGATOR design has the lowest possible center of gravity without compromising clearance under the sprayer.

Unique design with long drawbar

The long drawbar is one straight line from the coupling point to the axle. Being bolted underneath the frame, it ensures good driving stability and absorbs the up-and-down forces at high-speed driving. The drawbar is available only as a fixed version.



Perfect clearance

The unique design of axle and frame ensures excellent crop clearance, reducing crop damages to the absolute minimum.



SmoothRide

The optional SmoothRide suspension system is uncomplicated, reliable and requires little or no service. The suspension provides shock resistance from rough terrain, ensuring higher capacity and comfort. SmoothRide suspension is standard on model 6000/6200 and model 4000 with 90/120 dualfold spc boom.

Liquid system

Work zone efficiency

To be able to handle large volumes of liquid with a minimum of pressure loss, the NAVIGATOR has large dimensions in all valves, tubes and filters.

SmartValve

All primary functions needed for filling or cleaning the sprayer are built into two handles located in the center of the working zone. The logically placed handles with easy-to-read icons make the system very easy to operate and greatly reduce the start-up and operation training for the operator.

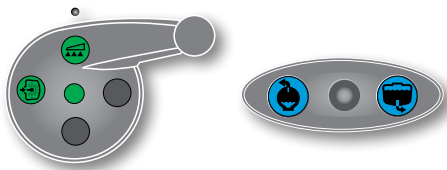

Cyclone Filter



TurboFiller

The HARDI TurboFiller is developed to handle large quantities of powders and liquids. Its high capacity is a result of high vacuum combined with rotation of the liquid forced by the TurboDeflector placed in the bottom of the hopper.

Changing from transport to the 37.5" high filling position is easily made by means of a spring-loaded bracket with automatic transport lock.

A multifunctional 3-valve operating unit and a cleaning pipe make the chemical filling easy and efficient. The cleaning of containers and the TurboFiller itself is easily managed by a rotating nozzle.

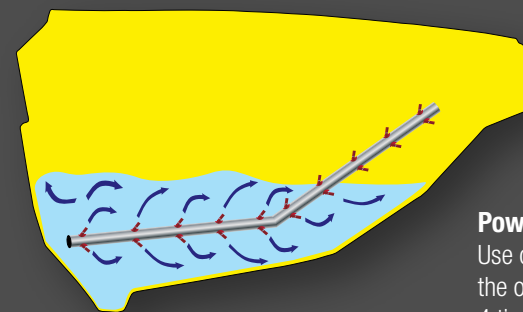

Powerful agitation

Use of Venturi nozzles increases the output for agitation by approx. 4 times.

The nozzles are positioned so there are no blind spots in the tank. This agitation process has proven to be extremely efficient for both liquid and powder.

PUMP Options

Performance Driven Options

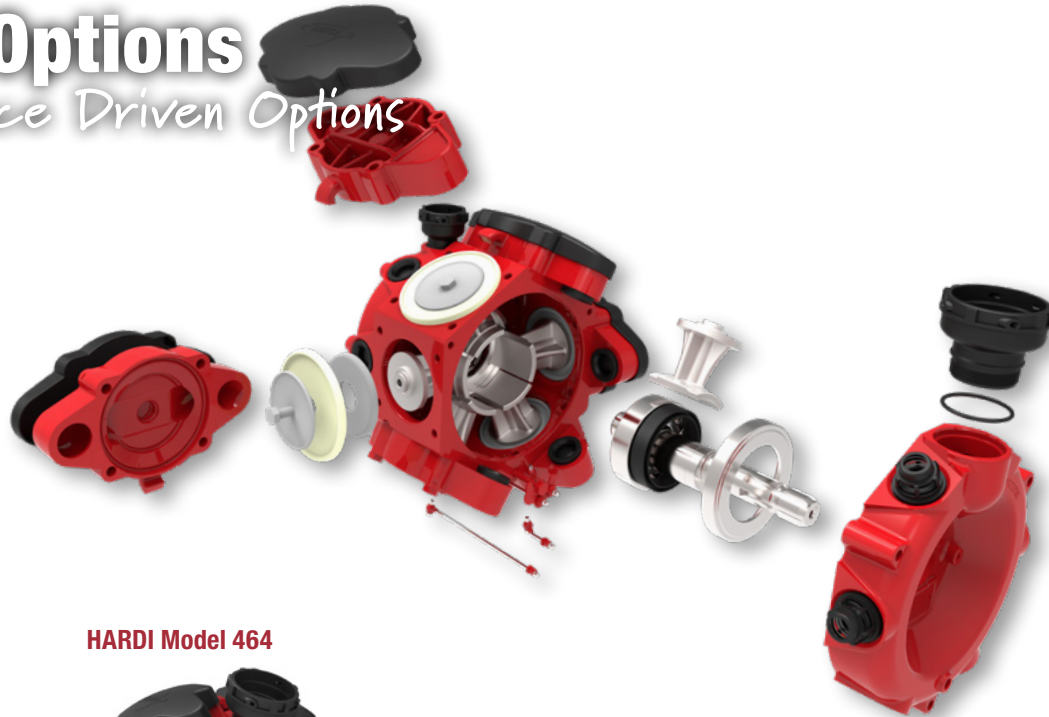

Pumps

To meet the requirements of bigger sprayers and to extend lifetime, we have introduced the HARDI 364 and 464 pumps. A reduction in pressure drop has been accomplished by improving the flow in the diaphragm tops. Available in either 540 rpm or 1,000 rpm PTO.

To ease service, we have integrated lifting hooks while moving two greasing points to the front, also making easier lubrication of the front and the rear of the pump. The casted con-rod support ring has also been redesigned for enhanced mechanical lifetime.

The Navigator 3000, 3500, 4000, and 6000 can also be driven by other pump options. The Navigator 4500 and 6200 can only be fitted with the HARDI Diaphragm pump. The Ace 206, 304 & 650 are hydraulic driven centrifugal pump. The line of Ace centrifugal pumps are designed to provide good resistance to abrasive solutions and extra flow for agitation. The advantages of the hydraulic motor driven pump are mounting versatility, customized performance, and ease of maintenance. All hydraulic driven pumps are equipped with a stainless steel shaft and wear ring for excellent corrosion resistance.

HARDI diaphragm pump features:

- ▶ Self-priming
- ▶ Able to run dry without damage
- ▶ Easy to service
- ▶ Grease-lubricated crankcase

HARDI Model 364

HARDI Model 464

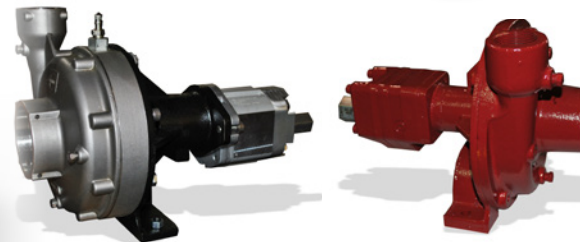

Optional Flush & Rinse Kit

The HARDI NAVIGATOR can be equipped with a Flush & Rinse kit for tank cleaning. The operator will control the flush and rinse option from the Work Zone.

- ▶ Easy operation
- ▶ Boom flush – clean water is used from the RinseTank and is flushed to the boom and sprayed out by the nozzles.
- ▶ Tank flush - clean water is used from the RinseTank and sprayed into the main tank.

EasyClean filter

The EasyClean filter is a high capacity suction filter. The condition of the filter can be constantly monitored via a SafeSpray vacuum gauge.

This ensures that the filter is cleaned when needed and only when needed. When cleaning the filter, all you have to do is to twist the lid 90°. This will close a main tank valve in the bottom of the filter and open the filter for inspection.

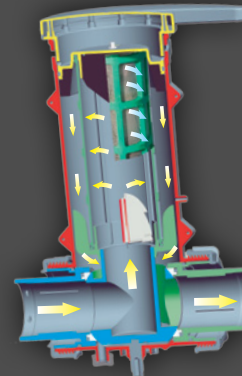

CycloneFilter

The CycloneFilter at the pressure side is a unique self-cleaning filter with a high-speed cyclone action that increases the cleaning capacity of the filter significantly.

In addition, the CycloneFilter has a unique boost function allowing the filter to be flushed when needed.

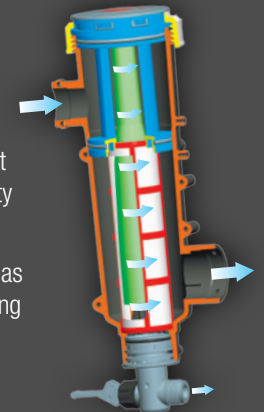

EAGLE SPB/SPC Booms

Excellent performance—Robust Structure

EAGLE SPB/SPC Booms

The 45 ft - 100 ft EAGLE boom is designed for heavy duty use under the most demanding conditions. The boom is well-known around the world for its performance under the hardest conditions.

The EAGLE boom is suspended on two large coil springs with shock absorbers. The horizontal movements are controlled by a heavy-duty trapeze system that allows spraying and turning at very high working speeds.

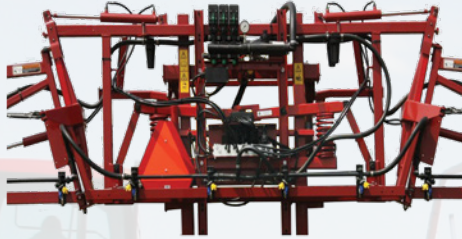

EAGLE DualFold SPC

HARDI has expanded the line of EAGLE booms with the addition of the 90'-60' and 120'-90' DualFold boom sizes.

Heavy dual spring suspension with dual shock absorbers on the 120' are designed to smooth the boom performance in the roughest no-till fields.



A non-directional spring loaded brake-away system protects the boom from damage. EAGLE booms are the solution if rough conditions and/or high driving speeds are required.



Z-Version Fold

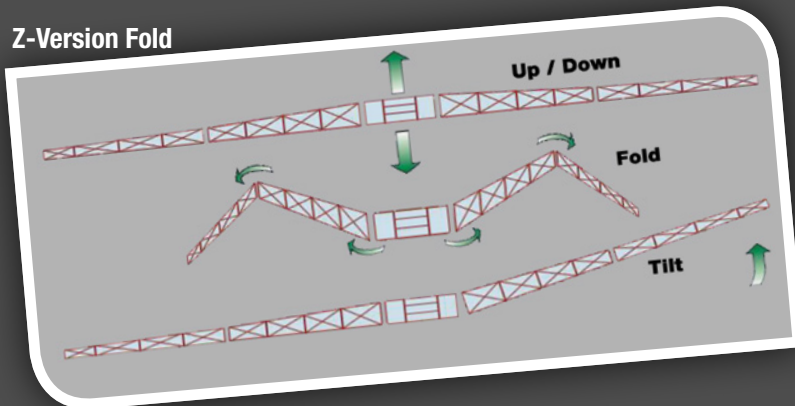

The EAGLE boom is available with two different hydraulic set-ups.

Y-version gives an easy folding where left and right side of the boom are folded symmetrically.

Z-version is electro-hydraulic and gives the possibility of individual tilt and individual-side folding.

DELTA FORCE boom

Compact in transport – Wide in field

DELTA FORCE is designed to be a large boom.

The selection of features and the layout of the boom structure are targeted to perform at high driving speed and high performance at boom widths of 90 ft, 120 ft, and 132 ft.

The result is a boom with many simple and strong solutions which together provide a high-performing and reliable boom with a simple setup, low maintenance and a great design.

20 inch nozzle space

DELTA FORCE boom are delivered with 20 inch standard nozzle spacing with the option of 15 inch spacing. The 88 ft and 132 ft DELTA FORCE booms can be set up with 22" nozzles.

With smaller nozzle space the boom height can be lower, which reduces the potential spray drift. To work with lower boom height the AutoTerrain boom management is the best condition.





Market's best boom stability

A very advanced, but yet simple center section controls the movements of the DELTA FORCE boom.

The self-stabilizing trapeze system allows adjustment to the boom performance, which follows the sprayer movements, or to follow the level of the terrain.

Hydraulic AntiYaw

Forces from yaw movements are absorbed by accumulators. The oil system is active and automatically recharged every time the boom is unfolding. The hydraulic AntiYaw is standard on 120 ft to 132 ft. The smaller versions have a mechanical system with rubber dampers as standard.

AutoHeight

With 3 sensors on the boom, the distance to the crop is measured several times per second. 3 gyrosensors measures the angle of the boom, the center section and the chassis. AutoHeight reacts before the boom gets out of balance giving you the possibility of higher driving speeds.

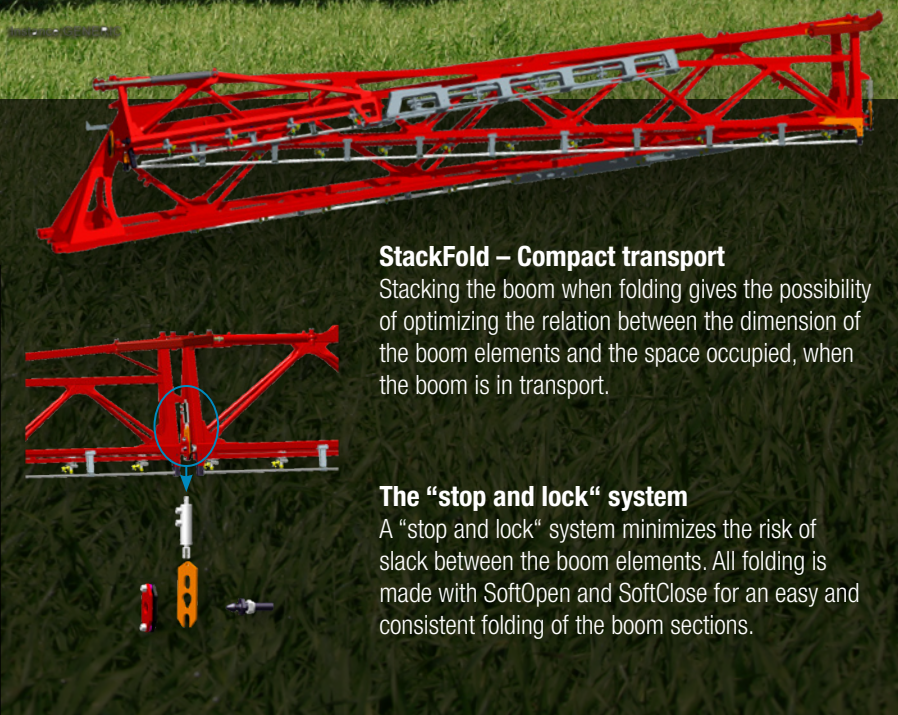

StackFold – Compact transport

Stacking the boom when folding gives the possibility of optimizing the relation between the dimension of the boom elements and the space occupied, when the boom is in transport.

The “stop and lock” system

A “stop and lock” system minimizes the risk of slack between the boom elements. All folding is made with SoftOpen and SoftClose for an easy and consistent folding of the boom sections.

HARDI DELTA FORCE is available in:

3-fold: 132'/90'/54', 120'/90'/54'

2-fold: 90'

120' DELTA FORCE

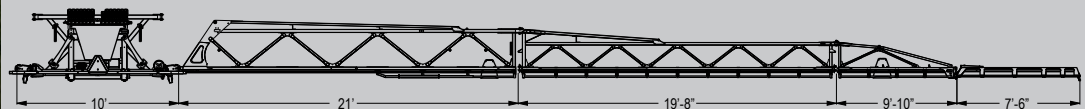

132' DELTA FORCE

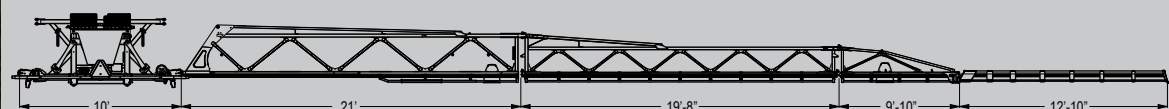

Controller System

Basic Rate Controller

HC 5500

HARDI Controller 5500 is more than a basic rate controller. It has many features that will enhance the liquid system on your sprayer and allow you to access more information on the work carried out.

Full integration

It is so simple to fit. The design is fully integrated with the other control boxes so the HC 5500 is the natural choice for your HARDI sprayer. It typically takes only one cable connection to connect. The sprayer control box already has the necessary plug.

Freedom of placement

The HC 5500 is small enough not to clutter the tractor cabin. It can be located independently from the controls. It is logical to locate it in the line of travel while the controls can be located close to the operator.

Large clear screen

The black text on green background is easy to read, even in bright sunlight. The 4" x 2" screen can show more than 5 lots of information simultaneously. The screen has back-lighting for night time spraying.

Quick start to go spraying

An available Quick Guide is enough to get you spraying. An in-depth explanation of functions and possibilities can be fully explored, step by step, in the comprehensive operators' manual.

Controller Display Options:

- Programmed and actual volume rate.
- Flow rate.
- Optional transducer readout.
- Actual time.
- Work rate.
- Actual volume rate.
- Actual tank contents.
- Actual speed.
- Volume and area covered.
- Active boom width.

Preset keys for everyday use

Changing the readout of vital information while spraying must be quick and easy. A series of presets for the readout of volume rate, speed, tank contents, area treated and total volume sprayed are at your fingertip. They will appear in the large format area of the screen.

Preset keys become short cut keys

Values that need to be altered from job to job, like programmed volume rate, can be accessed by a short cut through the preset keys.



Controller Options

Full control with complete integration

HC 8600 and HC 9600

The complete integration of all important information on one work screen is a highly demanded criterion for most farmers. The HC 8600 and HC 9600 have multicolour HD touch screens that are very easy to operate while providing an optimal overview for maximum control of the spray job.

Integrated electronics

From the working screen the driver can operate AutoHeight, AutoSectionControl as well as guidance and rate. The view can be switched between 2D and 3D when guidance is active. The HC 9600 is able to divide the information with split screen for a better overview.

Data management and data transfer

The HC 8600 and HC 9600 have USB ports and WiFi adapter as standard, allowing data to be exchanged. This simplifies application

reporting, providing an easy way to generate detailed application reports for governmental record keeping. Reports provide location, product information, applied totals, field areas, applied maps and field boundaries. The data can be transferred to different farm management software.

The HC 9600 automatically creates an application report in a pdf-format which can be saved, emailed or printed. For this no additional software is required.

Basic information about weather, soil conditions, products, etc. can be added.

Universal Terminal

The HC 8600 and HC 9600 displays are designed to meet the ISO 11783 ISOBUS Universal Terminal standard.

| Feature | HC 9600 | HC 8600 |
|---------------------------|-----------------|----------------|
| Dimension | 12.1" (30.7 cm) | 8.4" (21.3 cm) |
| ISOBUS Universal Terminal | ● | ● |
| USB ports | 2 x USB | 1 x USB |
| AutoSectionControl | ● | ● |
| Guidance | ● | ● |
| Coverage Mapping | ● | ● |
| Data Logging | ● | ● |
| Variable Rate Application | ● | ● |
| Smart Report™ | ● | N/A |
| Boom Height Control | ○ | ○ |
| AutoSteer Control | ○ | ○ |
| OptiRx® Crop Sensors | ○ | N/A |
| Camera Support | ○ | ○ |
| ISOXML data transfer | ● | ● |

● Standard ○ Optional



ISOBUS terminal

The HARDI NAVIGATOR can be operated with a universal ISOBUS terminal. The customer can order the NAVIGATOR and use the intelligent functions like AutoSectionControl direct from his own ISOBUS terminal if supported.

To make the complex sprayer operation easier, the proven HARDI JoyStick will be delivered with the NAVIGATOR sprayer.





Davenport,
USA



Nørre Alslev,
Denmark



Lleida,
Spain



Savigny,
France



Beaurainville,
France

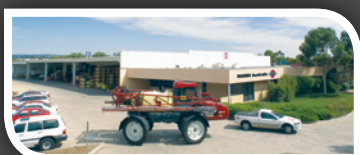

Adelaide,
Australia

HARDI

The Sprayer

HARDI INTERNATIONAL A/S

is an international group whose basic idea is to satisfy the user's requirements for quality products which ensure efficient, punctual and precise application of crop protection products. Our world-wide distribution and sales network comprise more than 100 countries where we are represented by importers, agents and sales subsidiaries. These are situated in Sweden, Norway, Denmark, the UK, France, Spain, North America, Germany and Australia.

Since 1957 HARDI has committed to the ever-increasing demands for efficient and precise plant protection. HARDI is the trendsetter within application of crop protection products. To achieve this position continued developments and innovation are essential. HARDI is committed to the long term future of plant protection.

Testing procedures

Sprayers leaving HARDI North America are tested according to the strictest quality standards.

The staff of the assembly line is accredited to match the demands from both NSTS (National Sprayer Testing Scheme), UK and JKI (Julius Kühn Institut), Germany. This ensures that the highest quality sprayers are delivered to farmers.

Technical Specifications

| Model/Tank size, | 3000 (800 gal.) | 3500 (1,000 gal.) | 4000 / 4500 (1,200 gal.) | 6000 / 6200 (1,600 gal.) |
|--|-------------------------|-------------------------|--|--|
| Pumps, type -rpm | HARDI 464 (540 or 1000) | HARDI 464 (540 or 1000) | HARDI 464 (540 or 1000) | HARDI 464 (540 or 1000) |
| | HARDI 364 (540 or 1000) | HARDI 364 (540 or 1000) | HARDI 364 (540 or 1000) / NA | HARDI 364 (540 or 1000) / NA |
| | Ace 650 - Hyd Drive | Ace 650 - Hyd Drive | Ace 650 - Hyd Drive / NA | Ace 650 - Hyd Drive / NA |
| | Ace 200 - Hyd Drive | Ace 200 - Hyd Drive | Ace 200 - Hyd Drive / NA | Ace 200 - Hyd Drive / NA |
| | Ace 150 - Hyd Drive | Ace 150 - Hyd Drive | Ace 150 - Hyd Drive / NA | Ace 150 - Hyd Drive / NA |
| Booms | EAGLE | EAGLE | NAV 4000 - EAGLE SPB/SPC NAV 4500 - DELTA FORCE | NAV 6000 - EAGLE SPC NAV 6200 - DELTA FORCE |
| Smooth Ride Suspension | Optional | Optional | Optional / Optional | Standard |
| Hydraulic outlets needed (HY models) | 2 | 2 | 2 / 1 | 1 / 1 |
| Hydraulic outlets needed (DHP models) | 1 double acting | 1 double acting | 1 double acting | 1 double acting |
| Weight drawbar (empty tank)*, lbs | 634 | 643 | 656 | 1,047 |
| Weight axle (empty tank)*, lbs | 6,956 | 6,972 | 6,989 | 9,370 |
| Weight total (empty tank)*, lbs | 7,590 | 7,608 | 7,645 | 10,417 |
| Total length, in* | A | 312 | 312 | 250.8 |
| Total height, in* (wheel size) | B | 150 (320/90 - R46) | 150 (320/90 - R46) | 156 (320/90 - R50) |
| Width | C | 138.5 | 138.5 | 138.5 |
| Track width, in (Select Axle Configurations) | D | 60 to 120 | 60 to 120 | 60 to 120 |
| Length draw to axle, in | E | 180 | 180 | 204 |
| Clearance, in (302/90-R46) | F | 27 | 27 | 27 |
| RinseTank gal | 130 | 130 | 130 | 130 |
| * 90 ft EAGLE Boom | | | | |

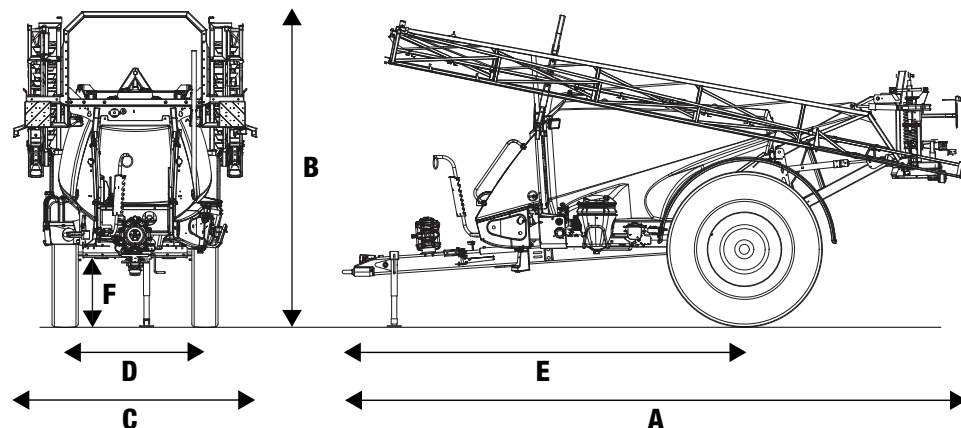

HARDI reserves the right to change the specifications without notice. Illustrations shown may include optional extras and accessories.



HARDI NORTH AMERICA

1500 West 76th Street, Davenport, IA 52806
E-mail: info@hardi-us.com · www.hardi-us.com
Phone: (563) 386-1730 Fax: (563) 386-1280



#SprayHARDI

HNA- 01.2019